

P/N: FAAIRD01-680K

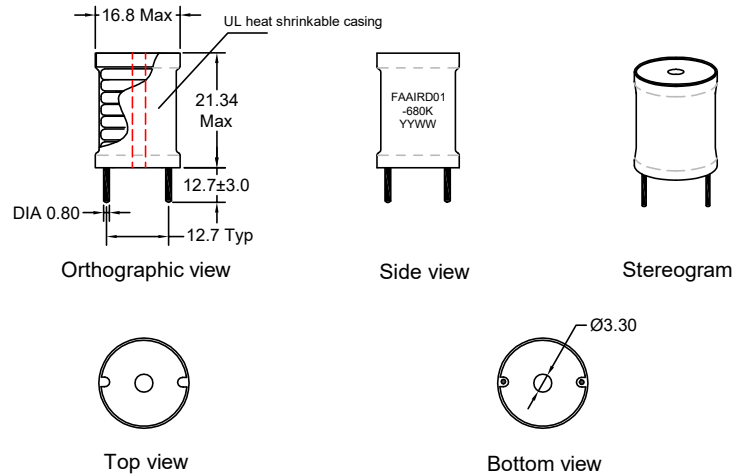

Outline Dimensions(Unit:mm)



REMARK:
1. Products need thermal shrinkable sleeve.

Electrical Schematic



Electrical Characteristics(@25°C)

Inductance 1KHz,0.1V S-F	DC Resistor	Rated Current
68.0uH±10%	0.077Ω Max	2.80A

***Operating Temperature: -40°C~+125°C.
(Temperature rise included)
***Storage Temperature : -40°C~+125°C.
***Storage Humidity:RH10%~70%.

Material list

Part Name	SPEC	Material Type	Supplier	UL Number
Core	DRH 20°14 (B=8.7)	NiZn	Huzhou Shuanglin Shitong magnetic factory	N/A
Copper Wire	1UEW-F	155°C	Elektrisola Hangzhou Co Ltd	E258243
Tube	RSFR-H/600V	125°C	ShenZhen Woer Heat-shrinkable Material Co Ltd	E203950

Recommended Soldering Temperature Graph.



	Standard Profile	Standard Profile
Pre-heating	150~180°C,90s±30s	
Heating	above 220°C,30s-60s	above 240°C,30s Max
Peak temperature	245°C±3°C	260°C,10s
Cycle of reflow	2 times	

REV	DESCRIPTION	APPD	DATE	Tianchang Fuan Electronic Co Ltd www.fuantronics.net TEL: +86-550-7814888 FAX: +86-550-7831133	Tolerances unless otherwise specified: (.X)±0.50 (.XX)±0.25 Unit of measurement: mm	Make: Qiumei.Liu Checked: Beson. zhan Approved: Anson. zhan	DRAWING TITLE AIRD01 RADIAL HIGH CURRENT POWR CHOKE Material Number: A33RD01XS220	Customer Name: Document/Rev: 00 Specification Sheet: 1 of 1 Date of Recognition: Mar./16/2020
-----	-------------	------	------	---	---	---	---	--